

Hybrid Link

DIO IMPLANT



디오기술연구소
DIO RESEARCH & DEVELOPMENT INSTITUTE

Hybrid Link (UF)

UF

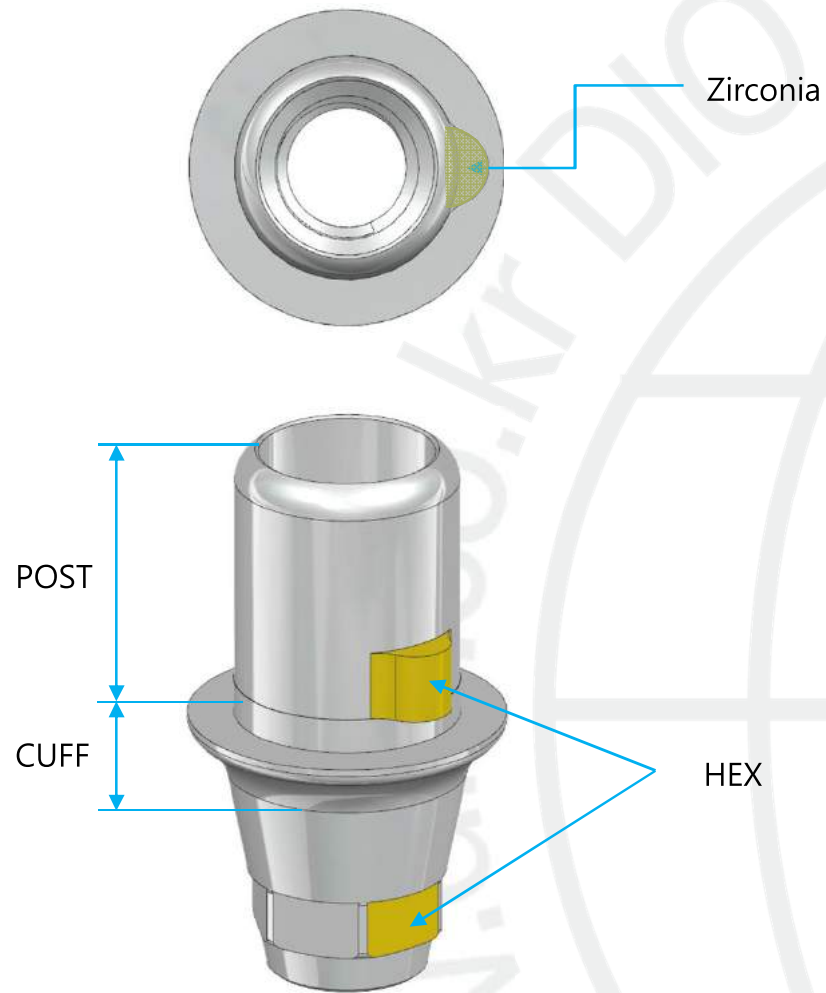



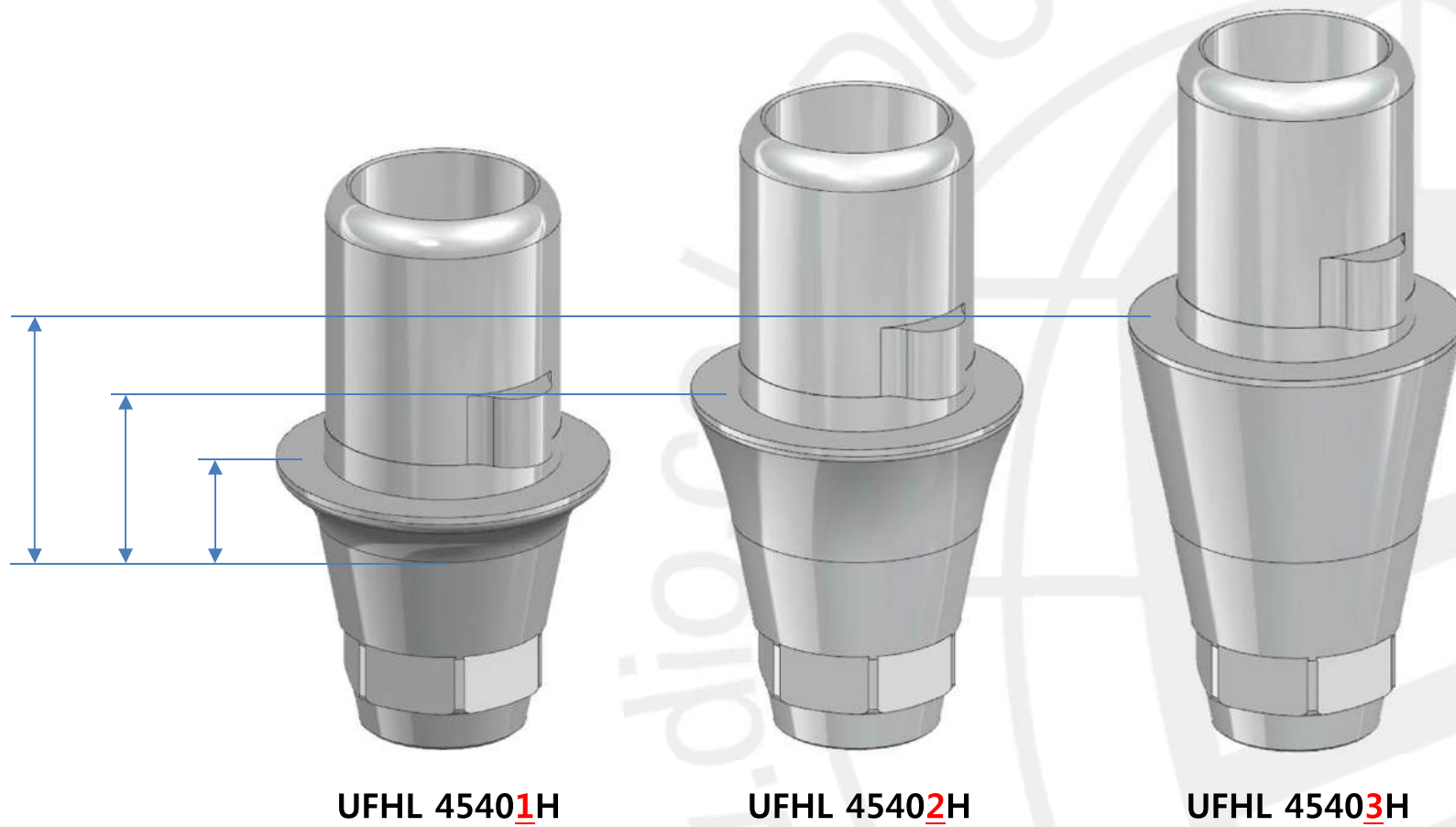



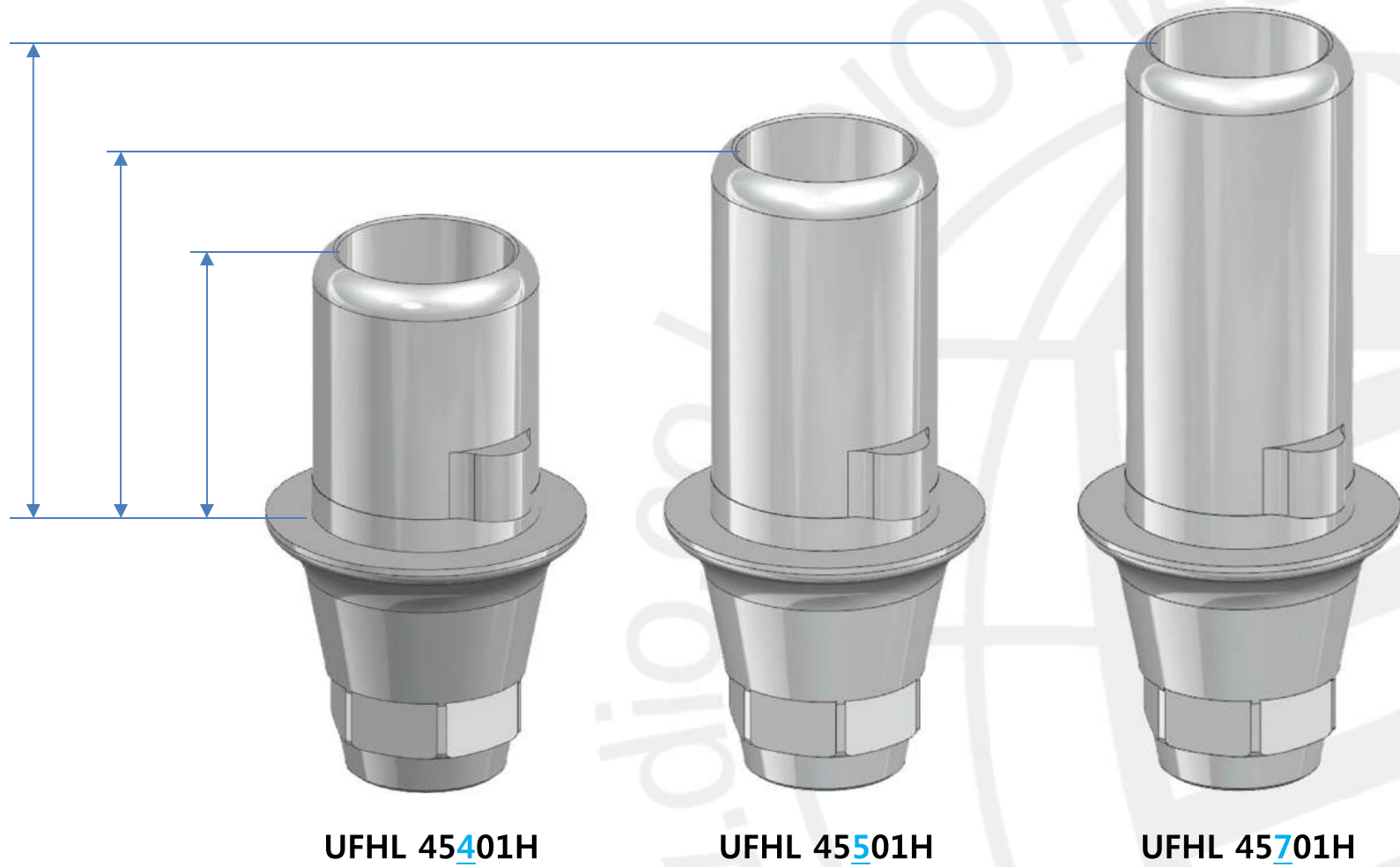











UF Hybrid Link Size (CUFF)





















UF Hybrid Link Size (POST)



		HEX			NON-HEX		
Cuff	Post	4mm	5.5mm	7mm	4mm	5.5mm	7mm
	1mm						
UFHL 45401H		UFHL 45501H	UFHL 45701H	UFHL 45401N	UFHL 45501N	UFHL 45701N	
2mm							
	UFHL 45402H	UFHL 45502H	UFHL 45702H	UFHL 45402N	UFHL 45502N	UFHL 45702N	
3mm							
	UFHL 45403H	UFHL 45503H	UFHL 45703H	UFHL 45403N	UFHL 45503N	UFHL 45703N	

UF Hybrid Link LIST ($\Phi 5.5$)

		HEX			NON-HEX		
Cuff	Post	4mm	5.5mm	7mm	4mm	5.5mm	7mm
	1mm						
UFHL 55401H		UFHL 55501H	UFHL 55701H	UFHL 55401N	UFHL 55501N	UFHL 55701N	
2mm							
	UFHL 55402H	UFHL 55502H	UFHL 55702H	UFHL 55402N	UFHL 55502N	UFHL 55702N	
3mm							
	UFHL 55403H	UFHL 55503H	UFHL 55703H	UFHL 55403N	UFHL 55503N	UFHL 55703N	

Hybrid Link (SM)

SM

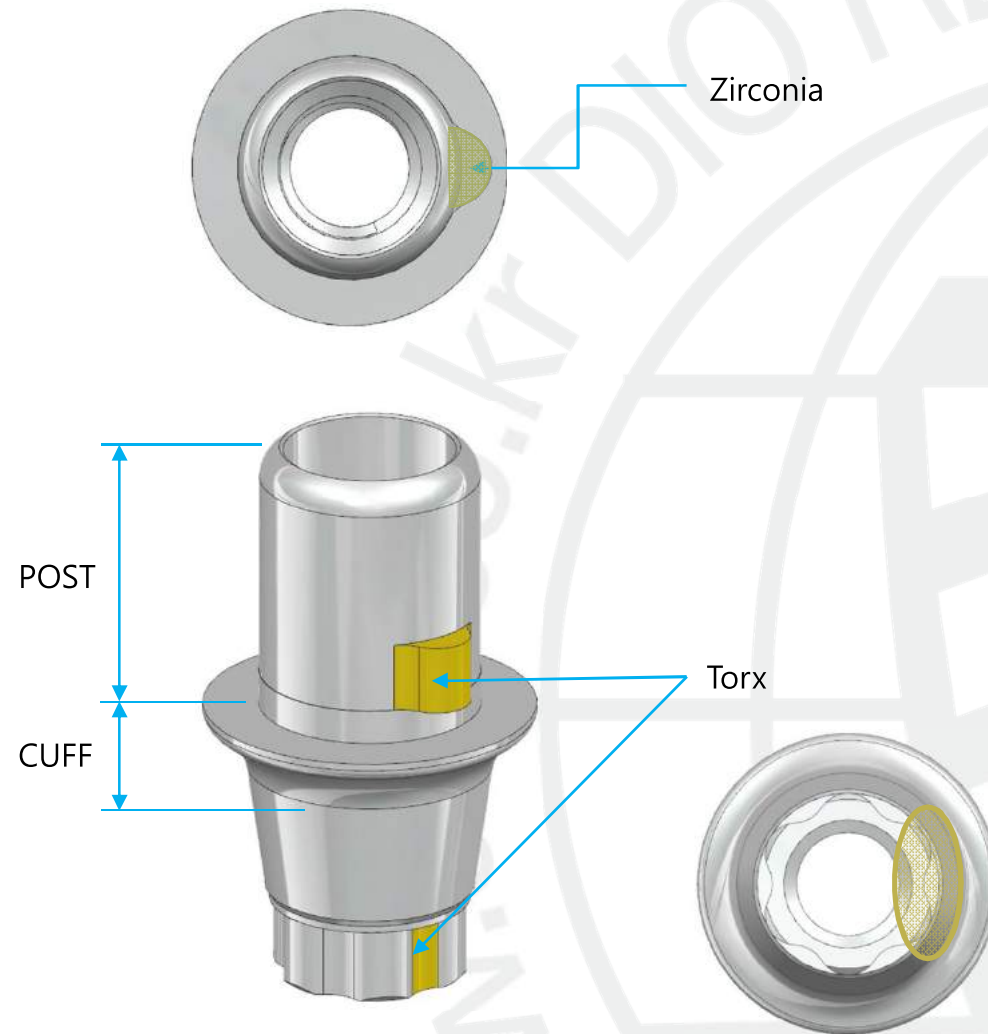



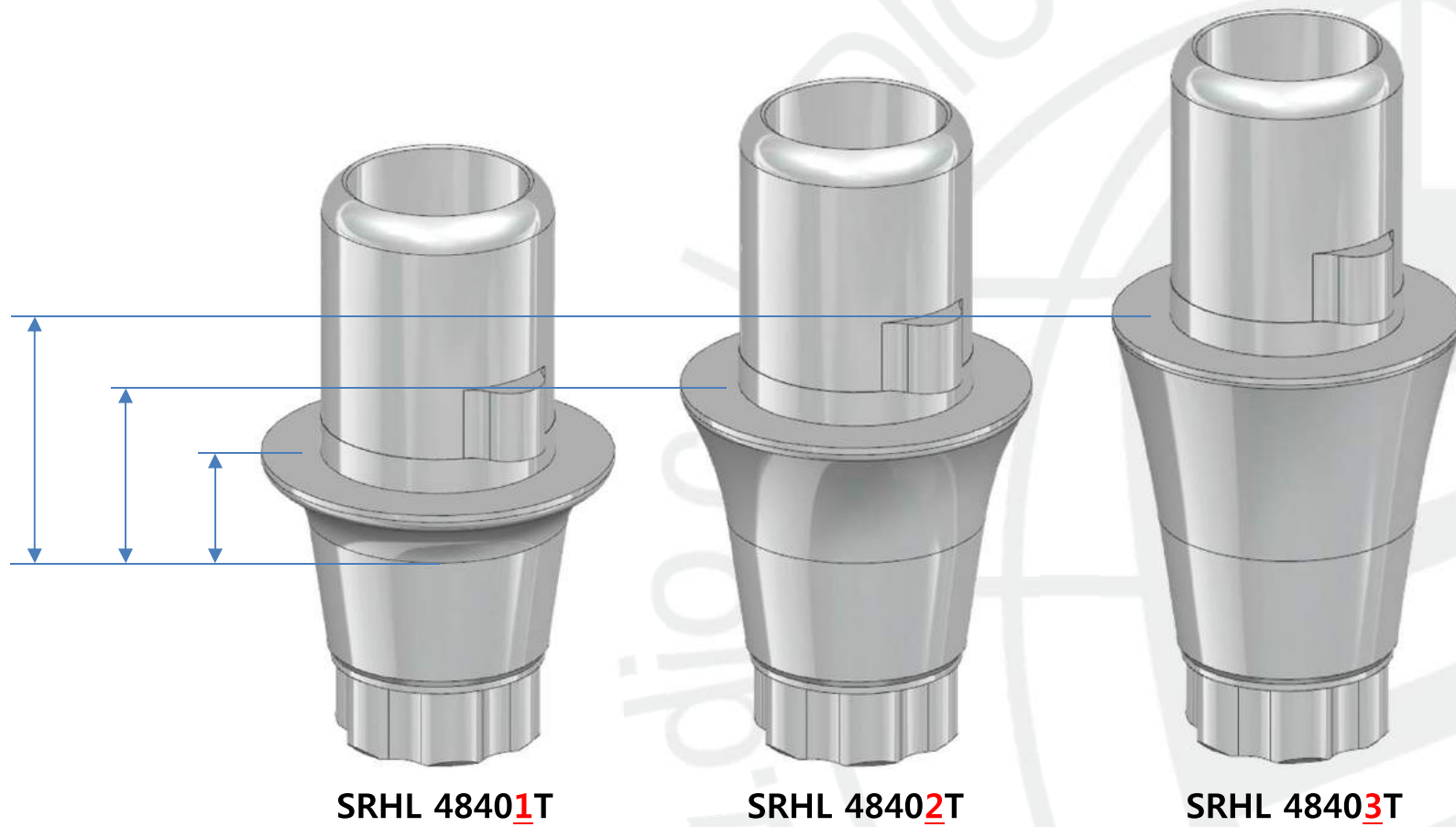



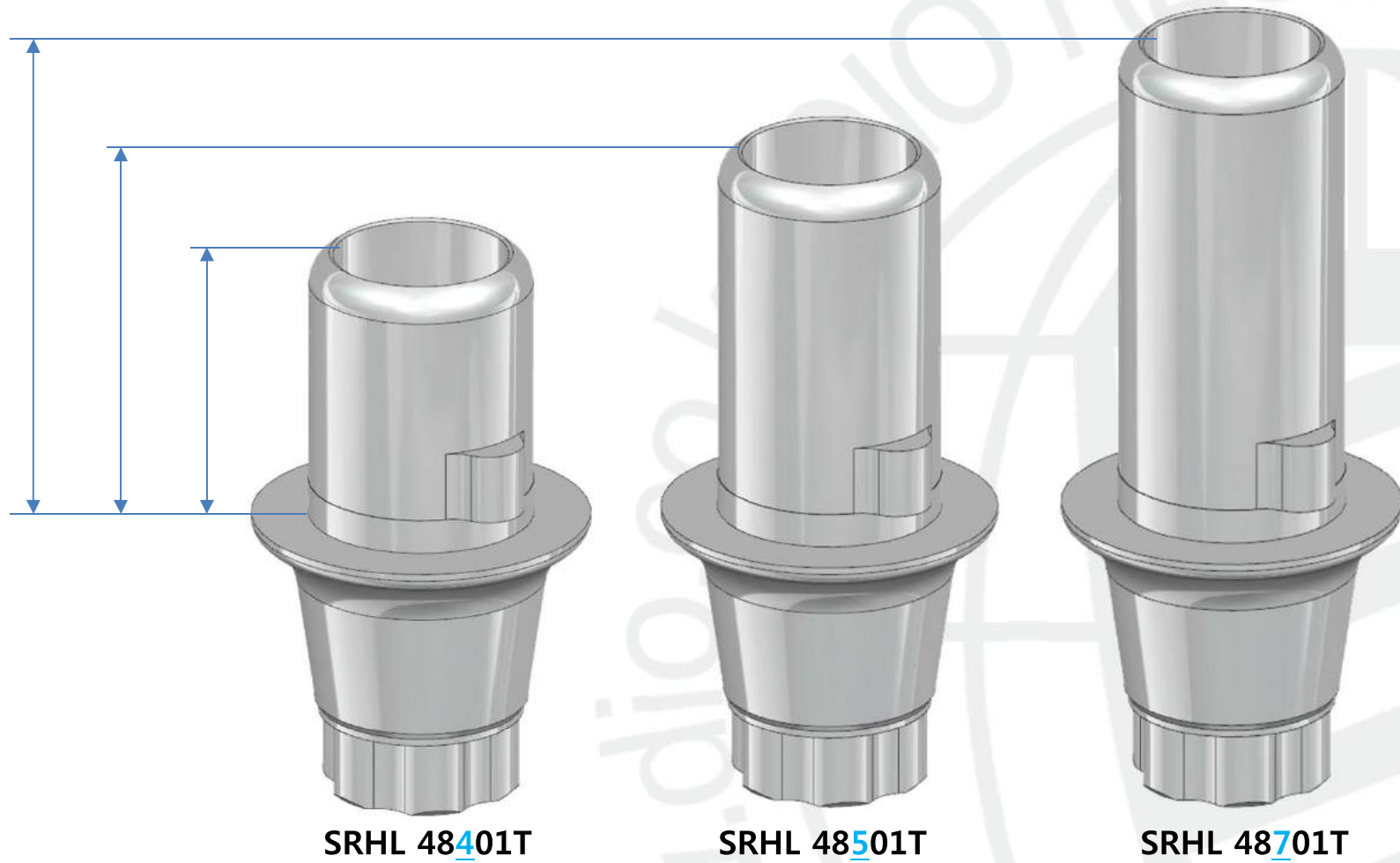











SM Hybrid Link Size (CUFF)





















SM Hybrid Link Size (POST)



SM Hybrid Link LIST (Narrow $\Phi 3.9$)

		TORX			NON-TORX		
Cuff	Post	4mm	5.5mm	7mm	4mm	5.5mm	7mm
	1mm						
		SNHL 39401T	SNHL 39501T	SNHL 39701T	SNHL 39401N	SNHL 39501N	SNHL 39701N
2mm							
		SNHL 39402T	SNHL 39502T	SNHL 39702T	SNHL 39402N	SNHL 39502N	SNHL 39702N
3mm							
		SNHL 39403T	SNHL 39503T	SNHL 39703T	SNHL 39403N	SNHL 39503N	SNHL 39703N

SM Hybrid Link LIST (Regular/Wide $\Phi 4.8$)

		TORX			NON-TORX		
Cuff	Post	4mm	5.5mm	7mm	4mm	5.5mm	7mm
	1mm						
SRHL 48401T		SRHL 48501T	SRHL 48701T	SRHL 48401N	SRHL 48501N	SRHL 48701N	
2mm							
	SRHL 48402T	SRHL 48502T	SRHL 48702T	SRHL 48402N	SRHL 48502N	SRHL 48702N	
3mm							
	SRHL 48403T	SRHL 48503T	SRHL 48703T	SRHL 48403N	SRHL 48503N	SRHL 48703N	

UF Narrow Hybrid Link LIST

Length	Ø4.0			Material
	Cuff 1	Cuff 2	Cuff 3	
4	UNHL 40401H	UNHL 40402H	UNHL 40403H	Ti-6Al-4V ELI
5.5	UNHL 40551H	UNHL 40552H	UNHL 40553H	

- Packing Unit: Abutment + Abutment Screw (UNSAS 1407H)
- : 20Ncm

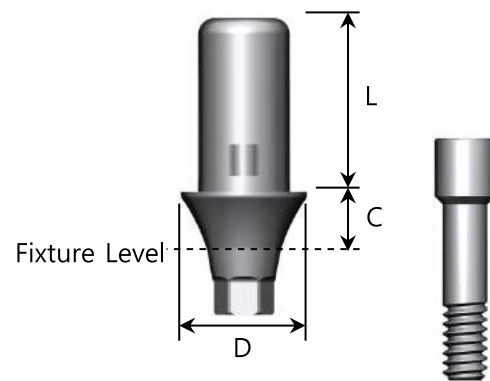

UCLA CCM Abutment

Cuff	Ø4.0	
	Hex	Non Hex
1	UNSCCA 4010H	UNSCCA 4010N
3	UNSCCA 4030H	UNSCCA 4030N

- Packing Unit: Abutment + Abutment Screw (UNSAS 1407H)
- : 20Ncm

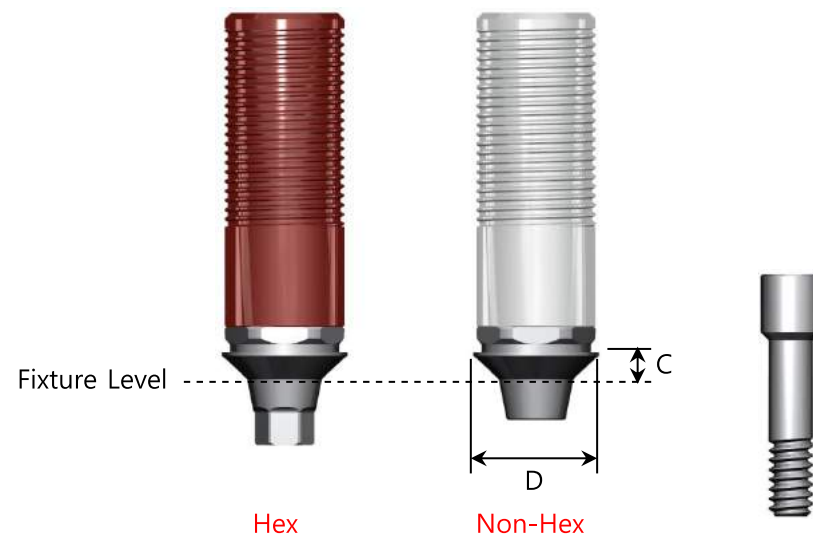

* Multi Unit Abutment

Cuff	Ø4.8	
	Hex	Non Hex
2.5	UNSMUA 482520H	UNSMUA 482520N
3.0	UNSMUA 483020H	UNSMUA 483020N
4.0	UNSMUA 484020H	UNSMUA 484020N
5.0	UNSMUA 485020H	UNSMUA 485020N

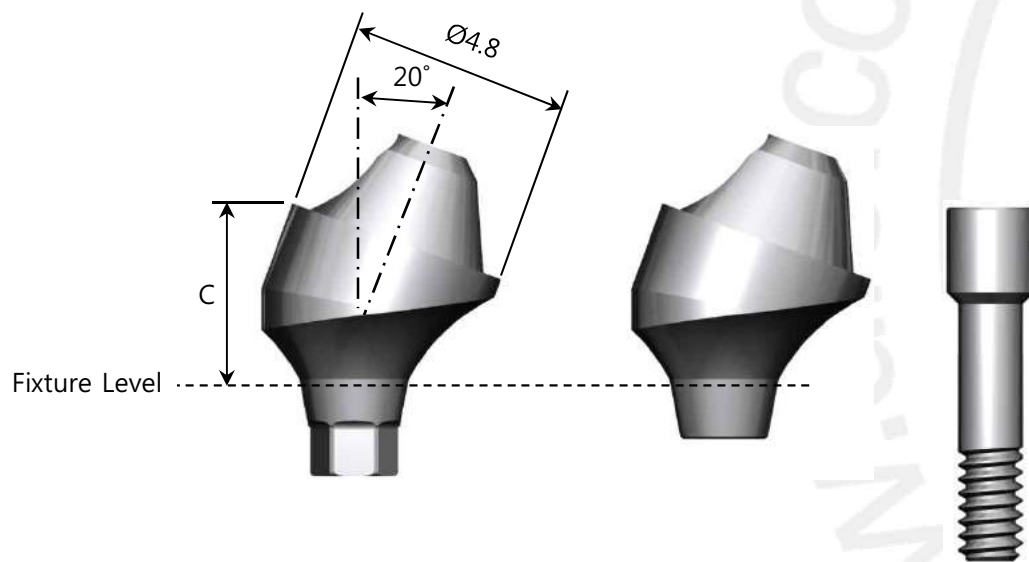

Conical Abutment

Cuff	Ø4.8	Material
1	UNSKA 4801	Ti-Gr4
2	UNSKA 4802	
3	UNSKA 4803	

•: 20Ncm

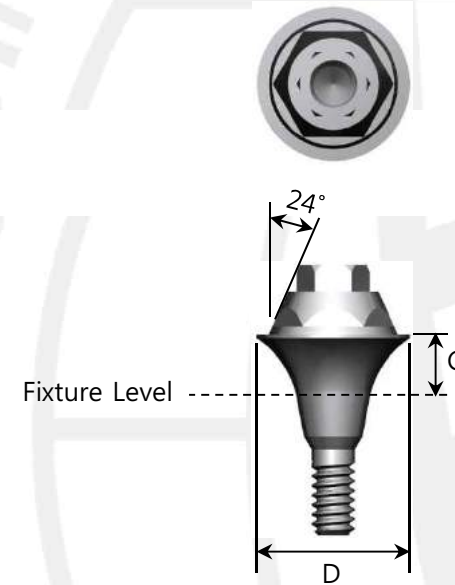

Thank you!

Planned and Developed by DIO

DIO IMPLANT



디오기술연구소
DIO RESEARCH & DEVELOPMENT INSTITUTE